

Car 6 - The Army Surplus Special

p1

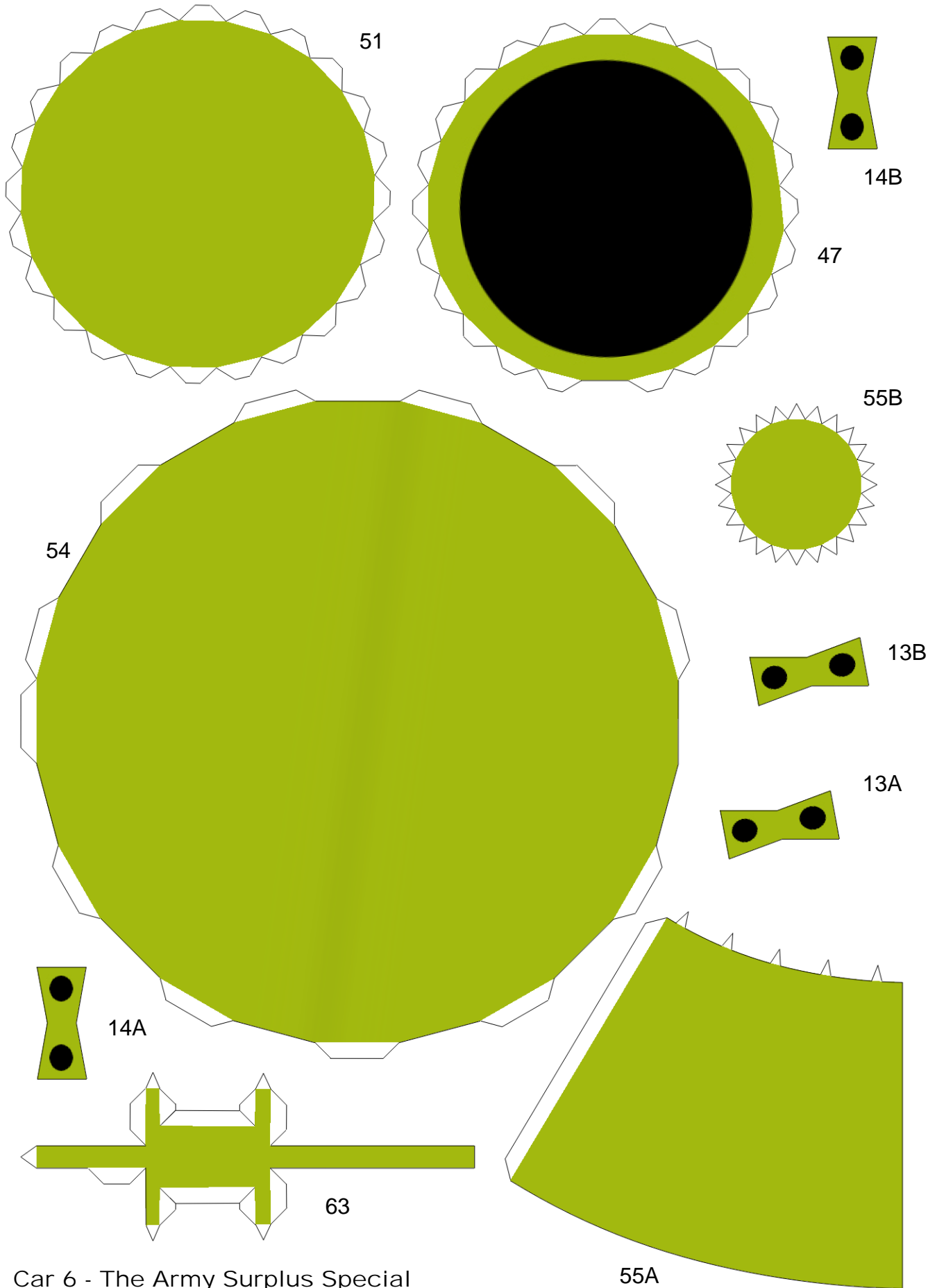

Car 6 - The Army Surplus Special  
p2

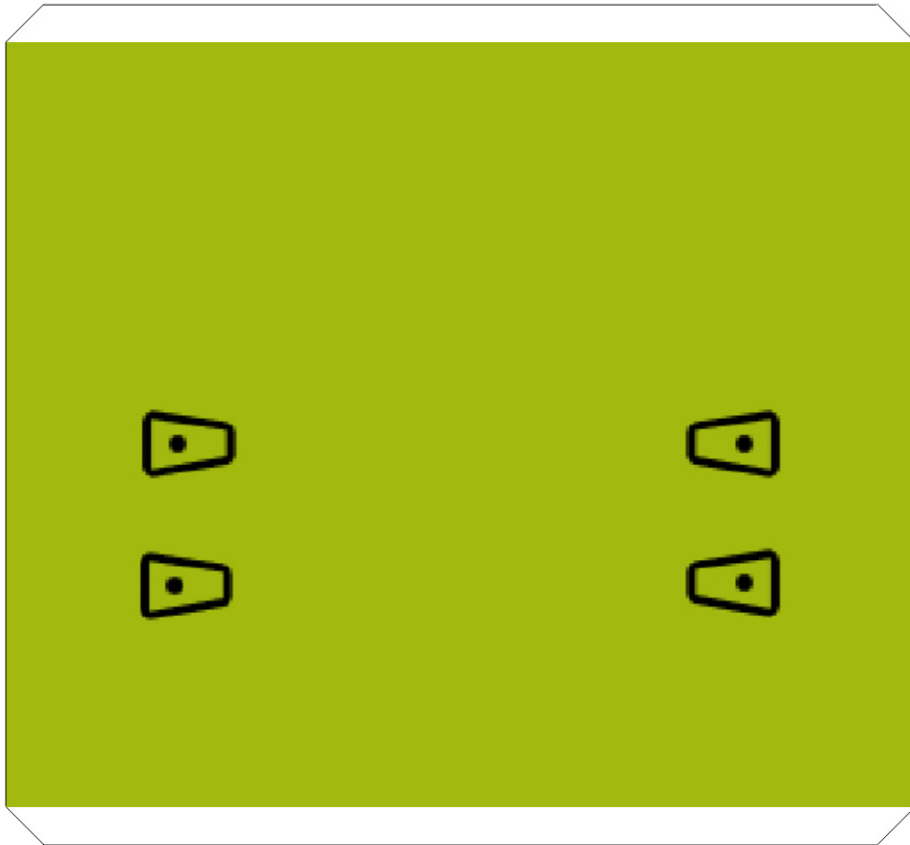

Hanna-Barbera's Wacy Races  
Car 6 - The Army Surplus Special  
Papercraft Pattern ©2005  
Papercraft by The Webdude  
<http://kickme.to/papermodels>  
NO COMMERCIAL USE AUTHORIZED

1

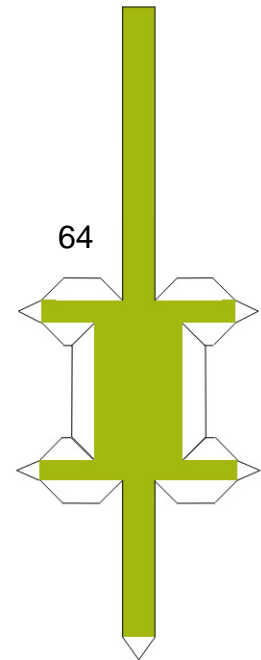
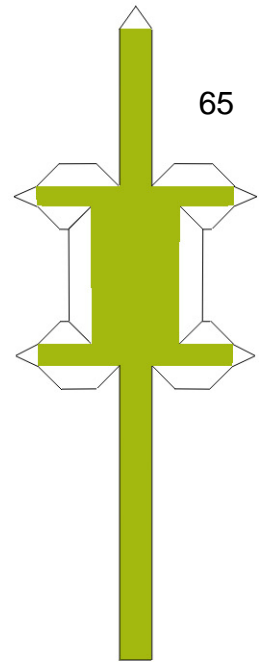

7

Hanna-Barbera's Wacy Races  
Car 6 - The Army Surplus Special p3  
Papercraft Pattern ©2005  
Papercraft by The Webdude  
<http://kickme.to/papermodels>  
NO COMMERCIAL USE AUTHORIZED



2

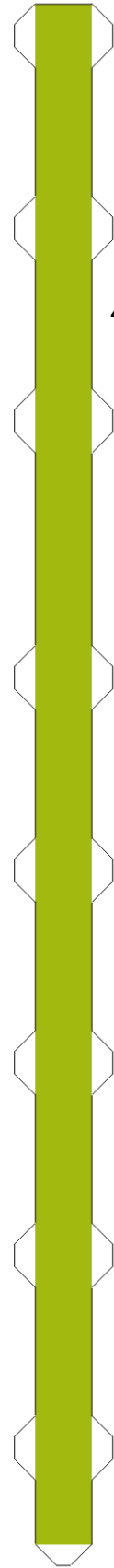

43



3



4

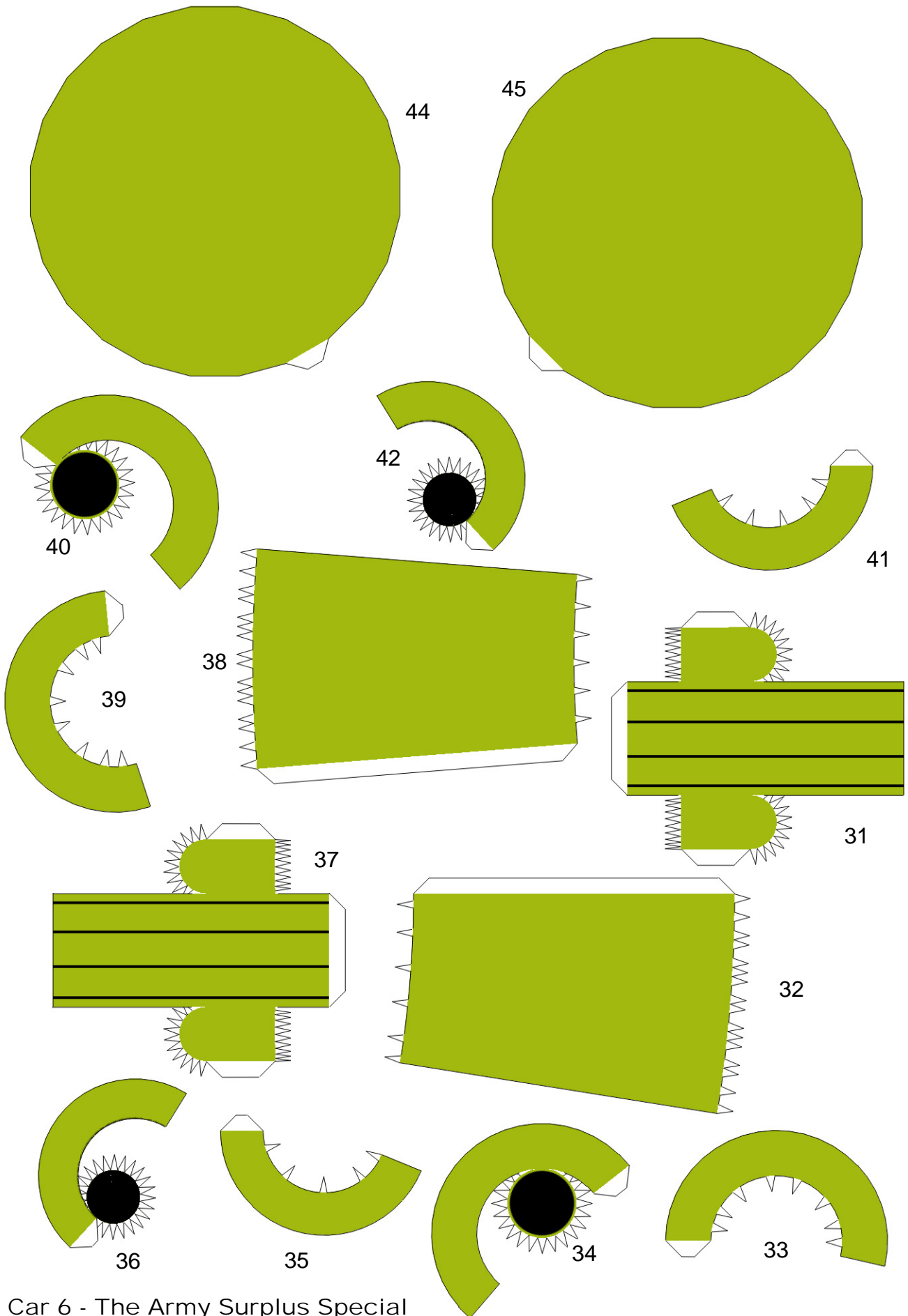

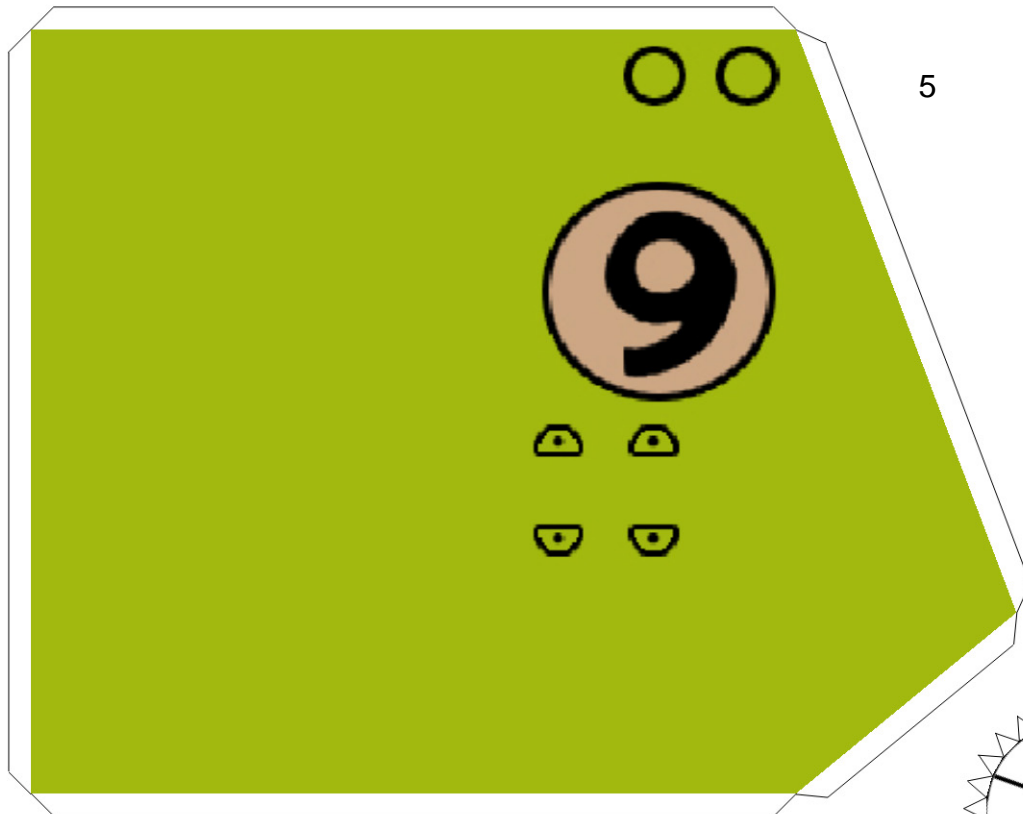

5

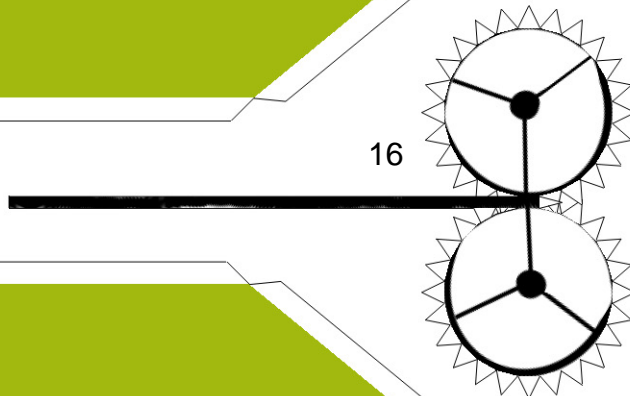

16

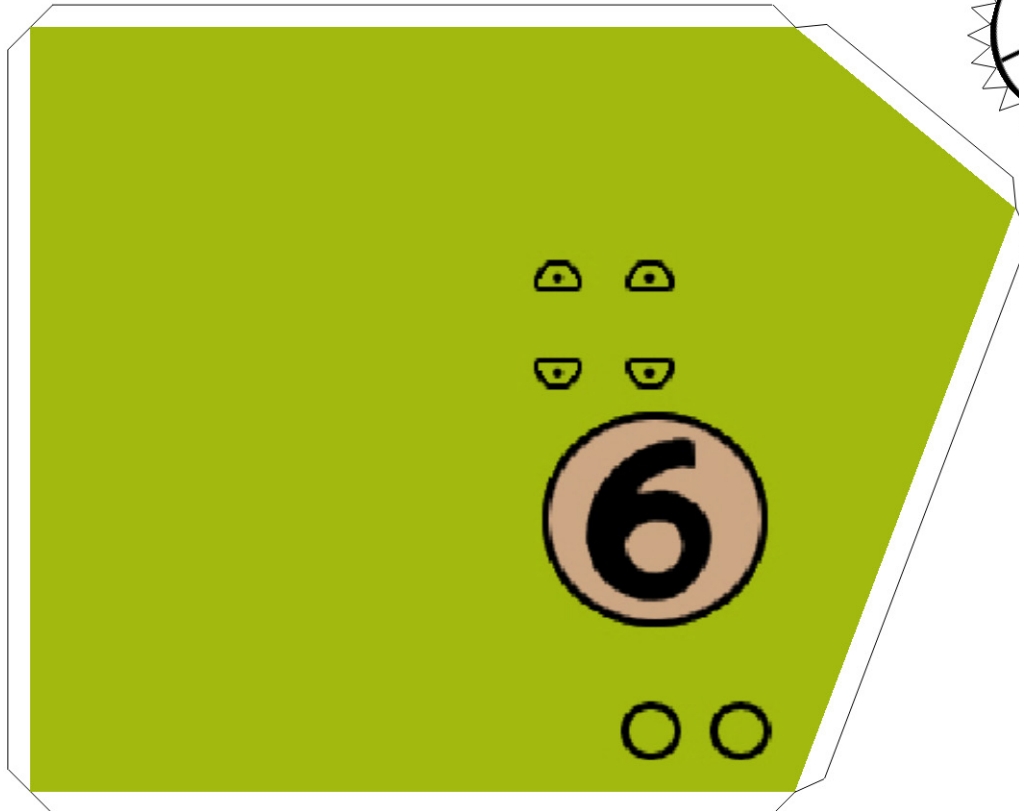

6

Car 6 - The Army Surplus Special  
p6

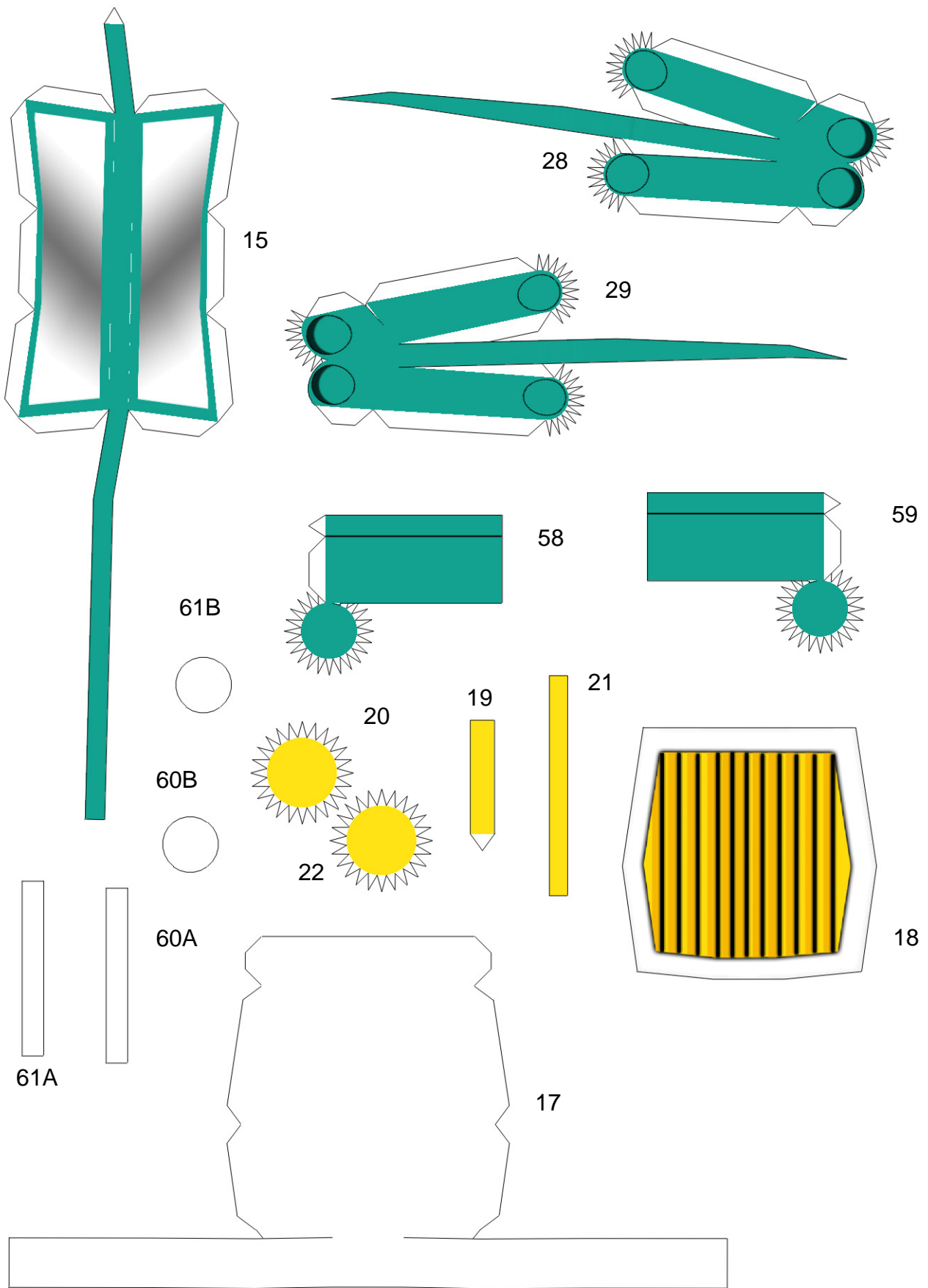

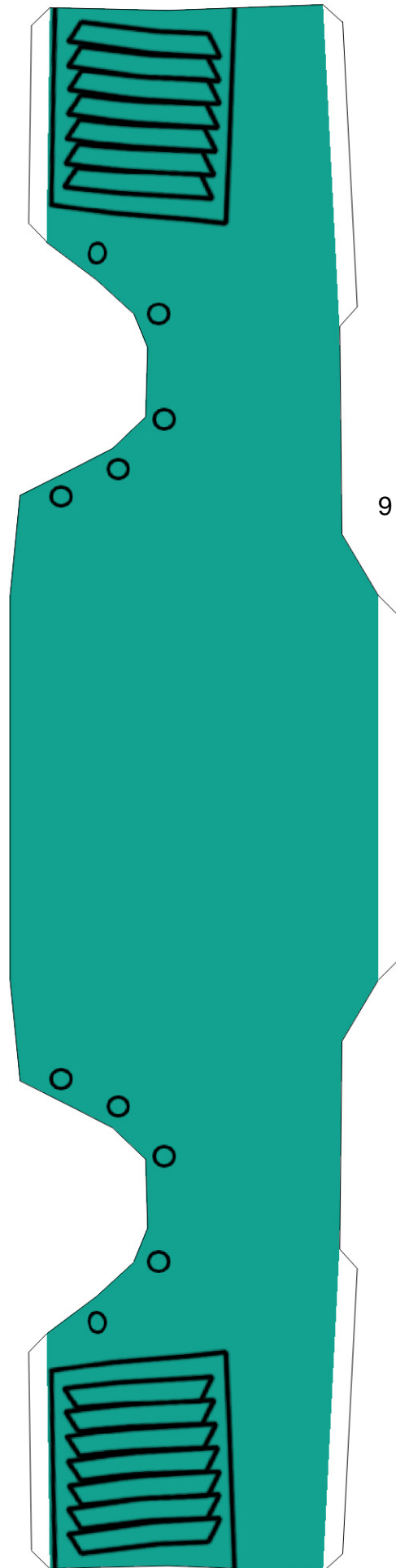
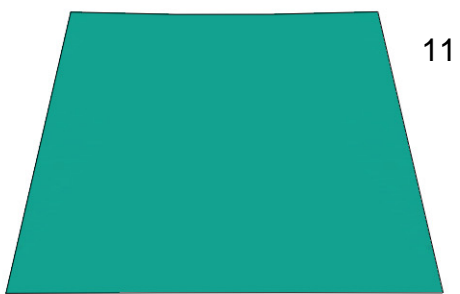
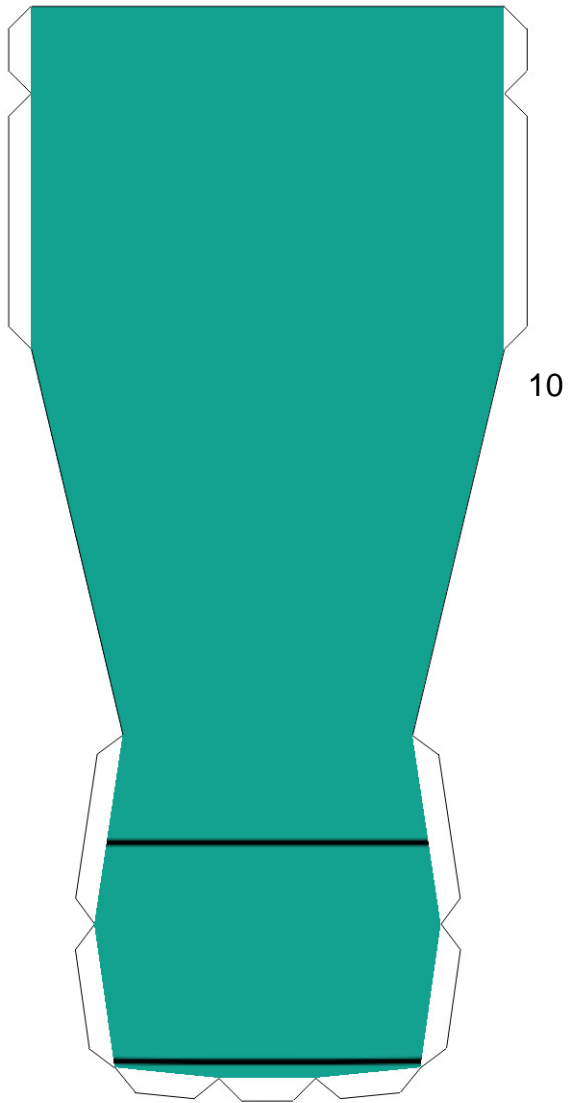



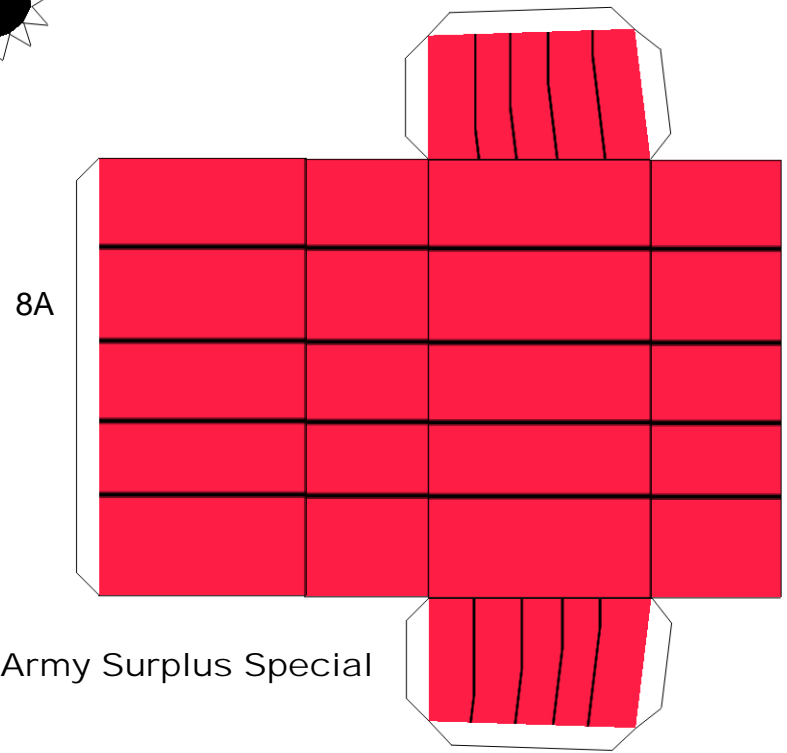
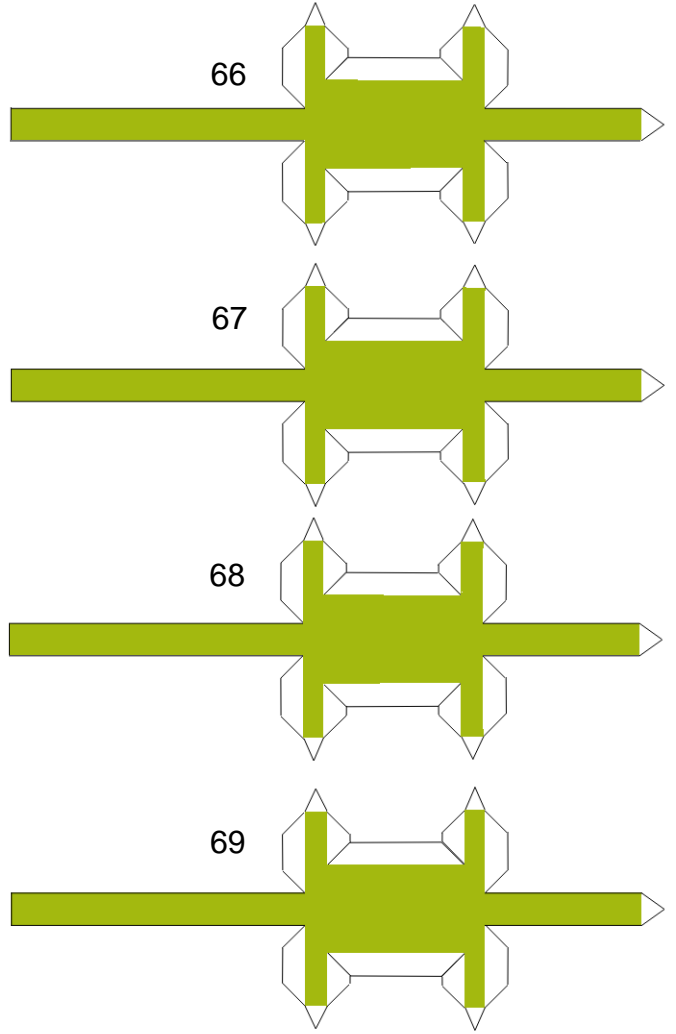
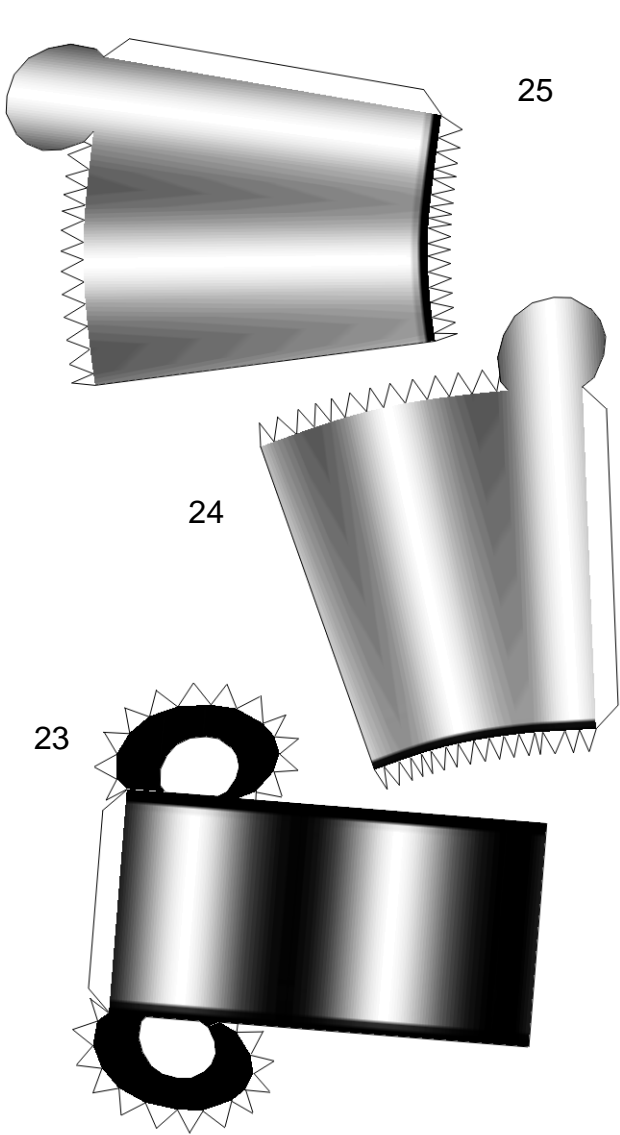

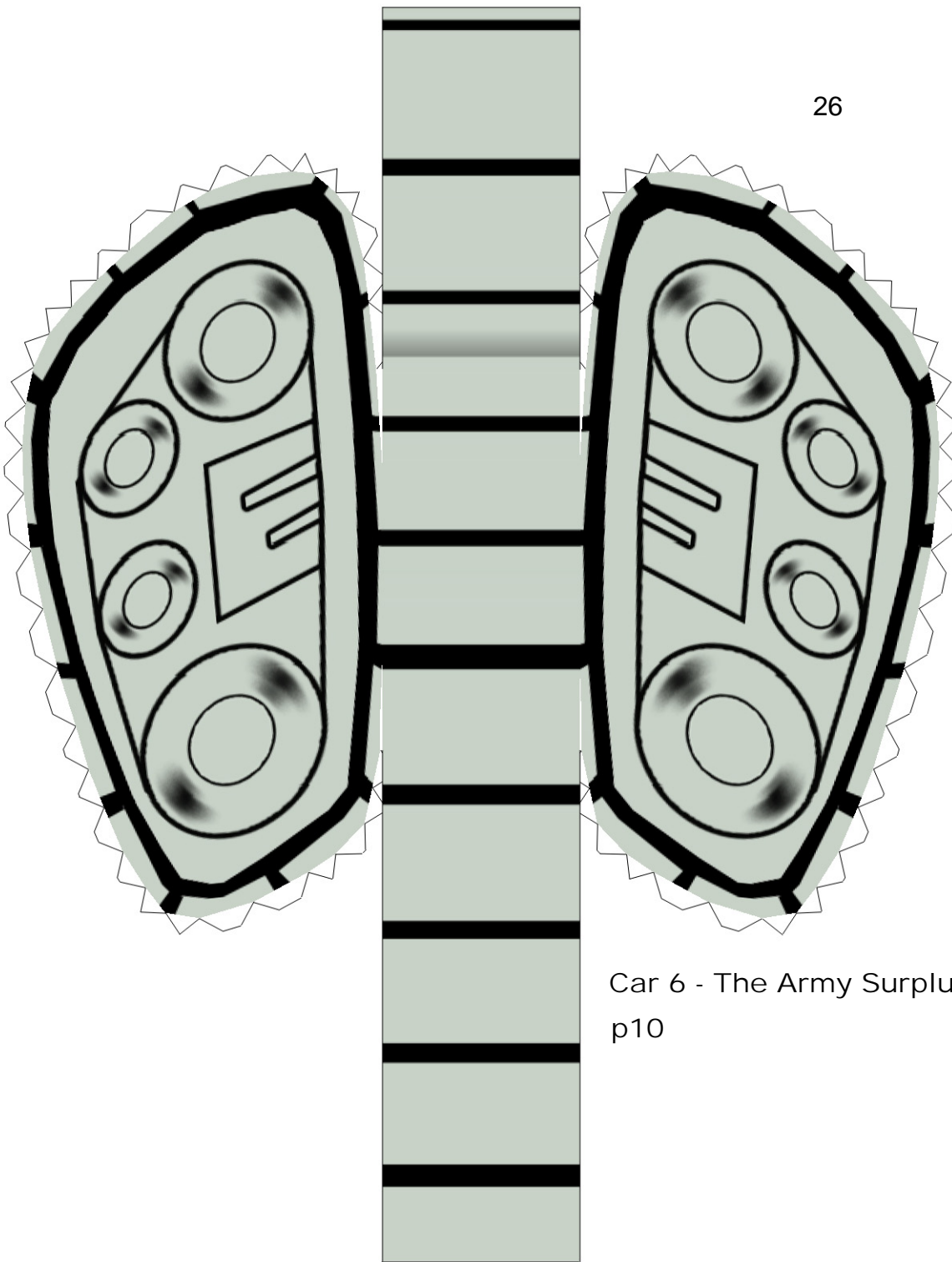

Car 6 - The Army Surplus Special  
p10

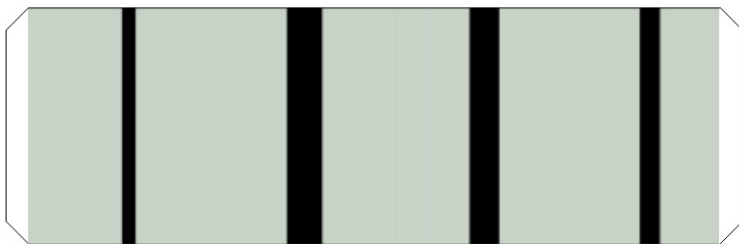

26A

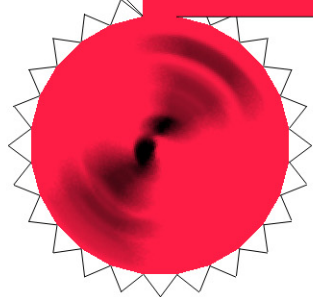
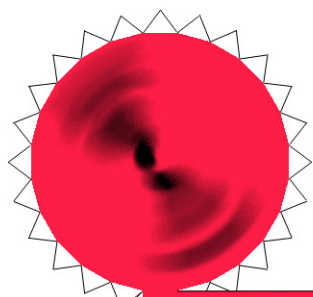

30

Insert Appx 6-10gm weight inside this piece!

Car 6 - The Army Surplus Special  
p11

27

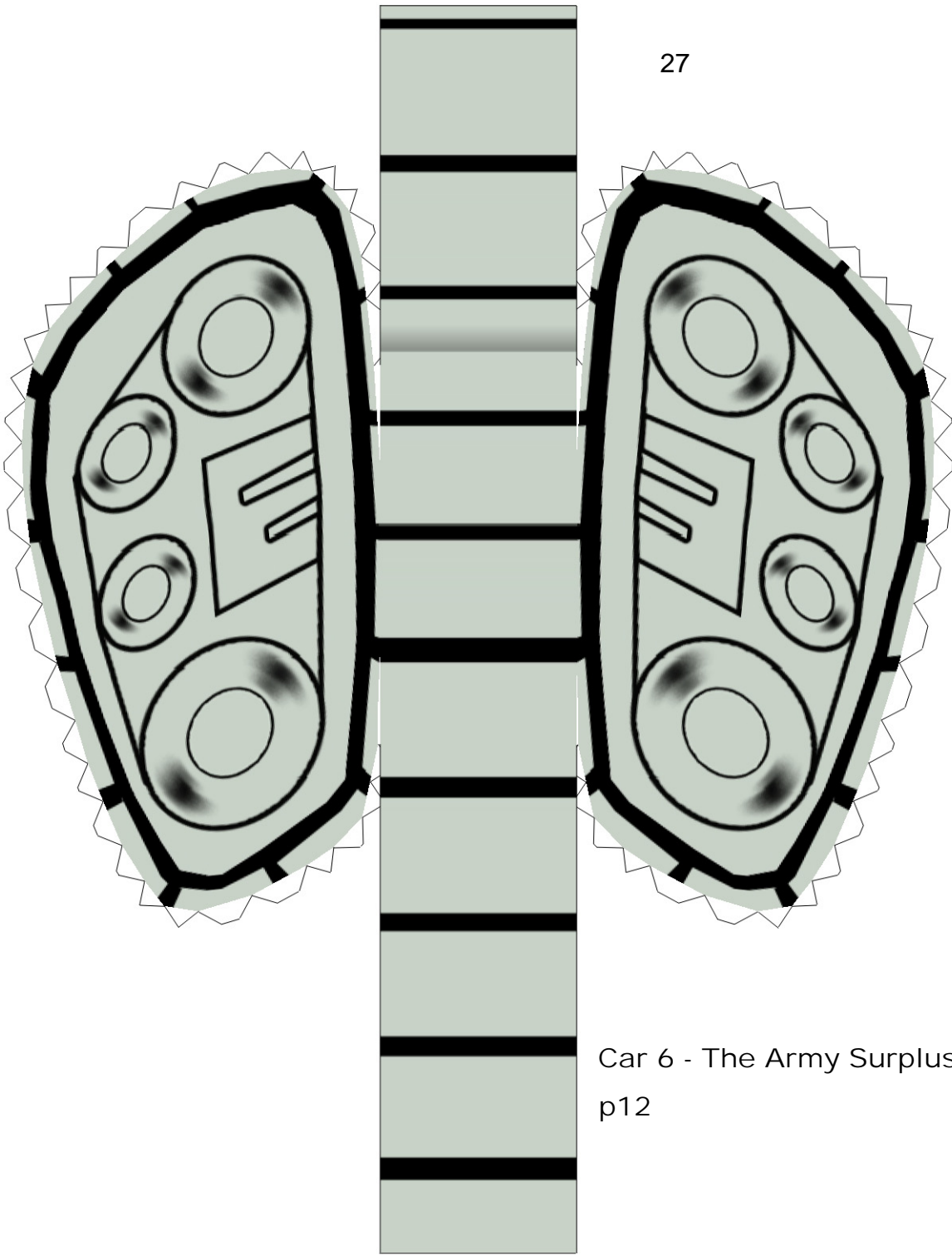

Car 6 - The Army Surplus Special  
p12



27A